



**For 3/4" board thickness**

TruBalance 3/4"

Classic 3/4"

**STAIR NOSINGS**

2,134 mm nosing for staircase or podium

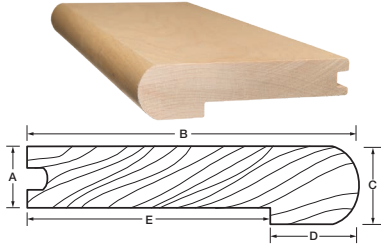

Round Stair Nosing

**Dimensions**

A	3/4"	19 mm
B	4-1/4"	108 mm
C	1-1/16"	27 mm
D	1"	25 mm
E	3-1/4"	83 mm

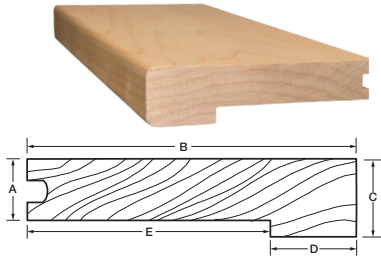

Square Stair Nosing

**Dimensions**

A	3/4"	19 mm
B	4-1/4"	108 mm
C	1-1/16"	27 mm
D	1"	25 mm
E	3-1/4"	83 mm

**MATCHABLE STAIR NOSING**

1,220 mm and 1,752 mm nosing for staircase or podium

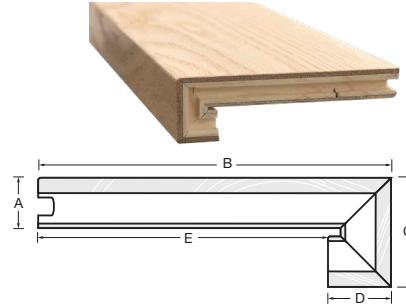

Matchable Square Stair Nosing

**Dimensions**

A	3/4"	19 mm
B	5-1/4"	134 mm
C	1-1/2"	39 mm
D	15/16"	24 mm
E	4-5/16"	110 mm

**STAIR COMPONENTS**

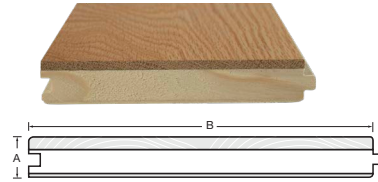

Tread & Riser Planks  
(Fixed 48" length plank in TruBalance 3/4" board thickness)

**Dimensions**

A	3/4"	19 mm
B	7-3/4"	197 mm

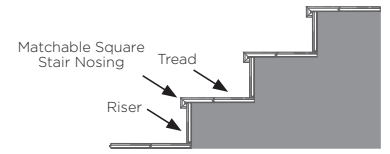

Please verify building code requirements in your area.

**REDUCER**

2,134 mm reducer for even floor transition

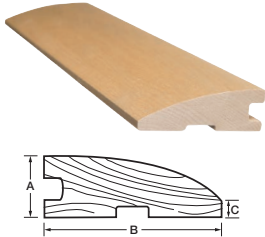

Round Reducer

**Dimensions**

A	3/4"	19 mm
B	2-1/4"	57 mm
C	1/8"	3 mm

**For 9/16" board thickness**

TruBalance Lite 9/16"

**MATCHABLE STAIR NOSING**

1,752 mm nosing for staircase or podium

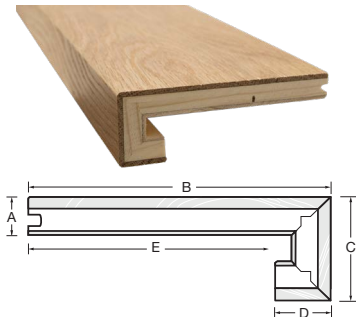

Matchable Square Stair Nosing

**Dimensions**

A	9/16"	14 mm
B	4-1/2"	114 mm
C	1-1/2"	39 mm
D	15/16"	24 mm
E	3-9/16"	90 mm

**REDUCER**

2,134 mm reducer for even floor transition.

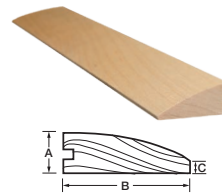

Round Reducer

**Dimensions**

A	9/16"	14 mm
B	1-1/2"	38 mm
C	1/8"	3 mm



For 7/16" board thickness

Lock 7/16"

STAIR NOSINGS

2,134 mm nosing for staircase or podium

For 3/4", 9/16" and 7/16" Board thickness

TruBalance 3/4"

Classic 3/4"

TruBalance Lite 9/16"

Lock 7/16"

MULTIFUNCTIONS

2,134 mm

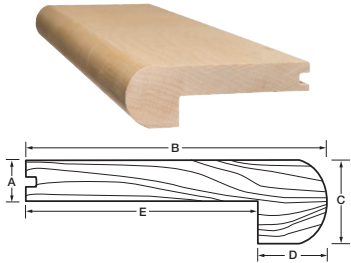

Round Stair Nosing (Glued Installation)

Dimensions

A	7/16"	11 mm
B	3-1/4"	83 mm
C	1"	25 mm
D	7/8"	22 mm
E	2-3/8"	60 mm

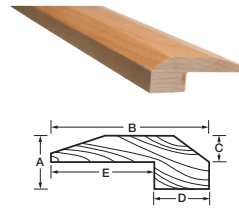

Threshold

Dimensions

A	3/4"	19 mm
B	2-1/8"	54 mm
C	3/8"	10 mm
D	3/4"	19 mm
E	1-3/8"	35 mm

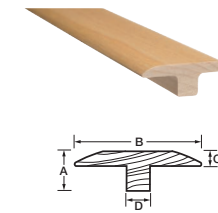

T Molding

Dimensions

A	9/16"	15 mm
B	1-13/16"	44 mm
C	3/16"	5 mm
D	3/8"	10 mm



Quarter Round

Dimensions

A	5/8"	16 mm
B	5/8"	16 mm

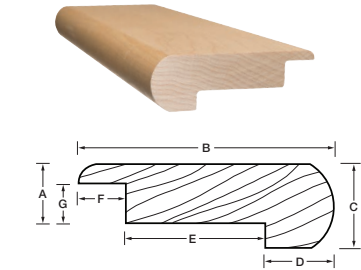

Round Stair Nosing (Floated Installation)

Dimensions

A	3/4"	19 mm
B	3-1/4"	83 mm
C	1-1/16"	27 mm
D	7/8"	22 mm
E	1-3/4"	45 mm
F	5/8"	16 mm
G	1/2"	13 mm

For 3/4" and 9/16" Board thickness

TruBalance 3/4"

Classic 3/4"

TruBalance Lite 9/16"

REDUCERS

2,134 mm reducer for even floor transition

WOOD MOUNT VENTS

Ensure optimal air circulation

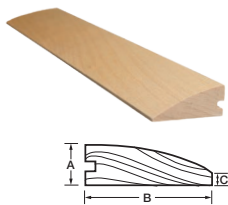

Round Reducer (Glued Installation)

Dimensions

A	7/16"	11 mm
B	1-1/2"	38 mm
C	1/8"	3 mm

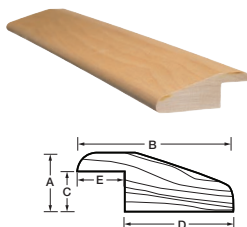

Round Reducer (Floated Installation)

Dimensions

A	3/4"	19 mm
B	2"	51 mm
C	1/2"	13 mm
D	1-3/8"	35 mm
E	5/8"	16 mm



Wood Flush Mount Vents\*

(For 3/4" board thickness)

Dimensions

A	3/4"	19 mm
B x C	4" x 10"	102 mm x 204 mm
D x E	6-3/4" x 13"	171 mm x 330 mm

(For 9/16" board thickness)

Dimensions

A	9/16"	14 mm
B x C	4" x 10"	102 mm x 204 mm
D x E	6-3/4" x 13"	171 mm x 330 mm

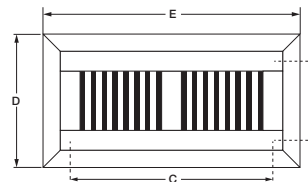

\* Dampers are included.